

Optical Cavities in Spectroscopy

Kevin K. Lehmann

Departments of Chemistry & Physics

University of Virginia

Talk Summary

- Review of Optical Cavities
- Review of Absorption Spectroscopy
- Molecular Beam Spec. with cavities
- Single atom detection with cavities
- Trace Gas Detection
 - FM Spectroscopy
 - Cavity Ring-Down Spectroscopy
 - NICE-OHMS
 - Intra-Cavity Laser Absorption Spectroscopy

Review of Optical Cavities (a.k.a etalons)

Simple Linear Optical Cavity

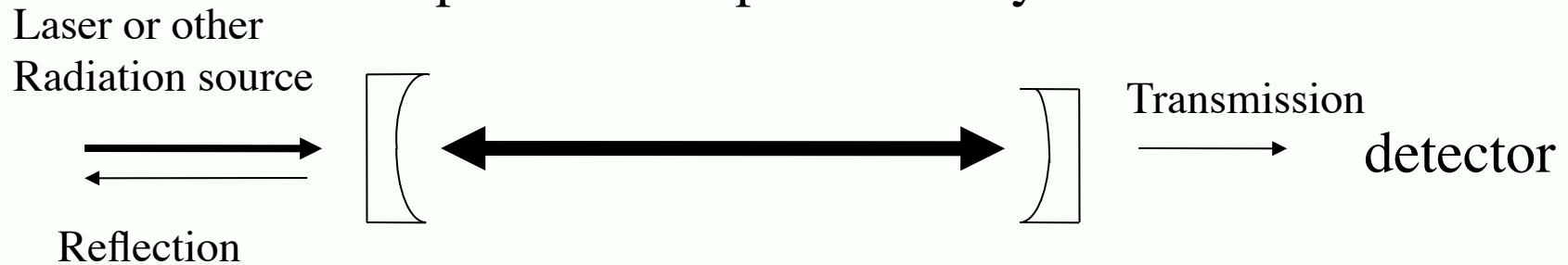

Radii of Curvature: R_1, R_2

Length of Cavity: L

Mirror Transmission: T

Mirror Reflectivity: R

Mirror Loss: $A = 1 - R - T$

Higher order Gaussian Modes ($z = 0$ is focus)

$$E_{m,n}(x,y,z) \propto H_n\left(\frac{\sqrt{2}x}{w(z)}\right)H_m\left(\frac{\sqrt{2}y}{w(z)}\right)\exp\left(-\frac{x^2+y^2}{w^2} - ik\frac{x^2+y^2}{R_f} - ikz + i(m+n,+1)\eta(z)\right)$$

$$w(z) = w_0\sqrt{1 + \frac{z^2}{z_0^2}} \quad z_0 = \frac{n\pi w_0^2}{\lambda_0}$$

$$R_f(z) = \frac{z^2 + z_0^2}{z} \quad \eta(z) = \tan^{-1}\left(\frac{z}{z_0}\right)$$

When you “see” a TEM₀₀ the laser beam it has diameter $\sim 2w$
 R_f is radius of curvature; infinity at focus and $\sim z$ far from focus.
 z_0 is confocal parameter; beam size increases by $\sqrt{2}$ for
 $z = \pm z_0$ from focus

An arbitrary electric field in any plane can be decomposed into TEM_{m,n} modes and each component propagates as above.

All distances measured in “optical path length”, i.e. n index of ref.

Stable Optical Cavities

- For $R = 1$, modes exist which exactly reproduce themselves upon round trip.
- $0 < L < R_1$ or $R_2 < L < R_1 + R_2$ ($R_1 < R_2$)
 - If $R_2 - R_1, \ll L$, then $R_1 < L < R_2$ only weakly unstable
- Optic axis defined by line through centers of curvature of mirrors (or normal to flat mirror).
- Light rays will oscillate around optic axis for stable cavity
- For cavity made of equal radii mirrors, focus in middle with

$$\omega_m = \left(\frac{\lambda L}{\pi} \right)^{1/2} \cdot \left(\frac{2L}{R_m} - \frac{L^2}{R_m^2} \right)^{-1/4} \quad \text{for} \quad R_1 = R_2 = R_m$$

- Radius of curvature of mode matches each mirror
- Confocal cavity: $L = R_1 = R_2$
 - Smallest spot size on mirrors for fixed L
 - Unstable if R_1 not exactly equal to R_2 !
- Concentric: $L = R_1 + R_2$.
 - On edge of stability (but stable is L very slightly reduced)
 - Spot size very small in center but large on mirrors.
- If $R_1, R_2 \gg L$. Mode is nearly uniform inside cavity

Cavity Transmission as function of Mirror Reflectivity, R , for ideal cavity and monochromatic radiation source

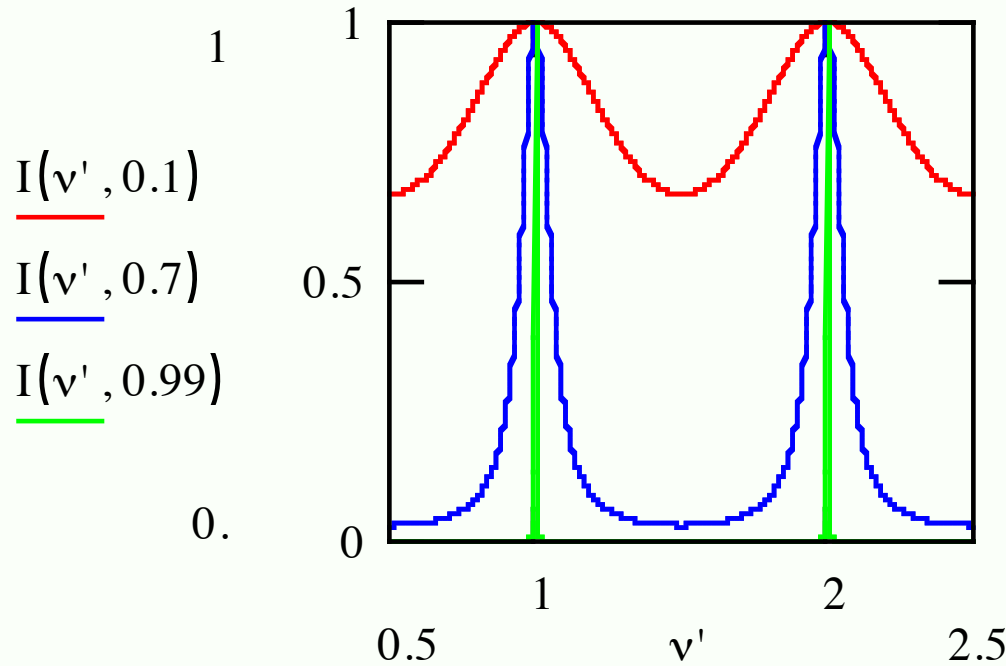

$$FSR = \frac{c}{2nL} = \frac{1}{t_r}$$

$$Finesse = \frac{\pi\sqrt{R}}{1-R} = \frac{FWHM}{FSR}$$

$$\tau = \frac{nL}{c \cdot (1-R)} \text{ Ring-down Time}$$

Quality factor: $Q = 1/(2\pi\nu\tau)$

Cavity mode width: $\Delta\nu_c = \frac{1}{2\pi\tau}$

Peak Transmission of Cavity
For perfectly monochromatic
Input radiation

$$\left(\frac{T}{1-R}\right)^2 = \left(\frac{T}{A+T}\right)^2$$

Peak Intracavity Gain

$$\frac{T(1+R)}{(A+T)^2}$$

Mirrors with $T, A \sim 5$ ppm are available in near IR and red

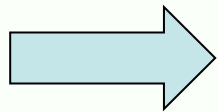

Intracavity power gain of $\sim 10^5$ can be realized

For $L = 40$ cm, FSR = 250 MHz, $(1-R) = 5$ ppm

$\tau = 400$ μ s but $\Delta\nu_c = 250$ Hz!

If linewidth of laser is much larger than mode, transmission
reduced by factor of $1/(1 + 2\pi\tau\Delta\nu_L)$

Transverse resonance modes of Cavities

$$\nu_r = \frac{c}{2L} \left(q + (m + n + 1) \cdot \delta_g \right)$$

$$\delta_g = \frac{1}{2} \left(1 + \frac{4}{\pi} \tan^{-1} \left(\frac{L - R_m}{L + R_m} \right) \right)$$

q is the longitudinal mode index (# of half waves in cavity)

m, n transverse mode numbers

Size of transverse modes increased by $(1 + m + n)^{1/2}$

If $\delta_g = M/N$, then we have rational cavity with periodic transmission spectrum. Arbitrary pulse inside Cavity will exactly reshape after N round trips -- such cavities are used for Herriott Cells.

For cavities made of 3 or more mirrors

Can be “linear” cavities with standing waves or “ring” cavities with Degenerate modes running clockwise and counter clockwise around cavity

Cavities will generally be astigmatic with TEM_{00} mode no longer circular and two different transverse mode spacings

Because of polarization dependence of phase shifts when light Reflects off of mirrors away from normal, modes with split by Polarization. If cavity is planer, one half of modes will be polarized in the plane (P) and the other perpendicular to that plane (S)

Stability conditions, mode spacings, and shapes can be determined using the ABCD matrix approach. (A. Siegman *Lasers*)

Are modes of cavities evenly spaced?

Important for coupling frequency combs into cavities.

Short answer is not exactly because of various sources of dispersion
This limits the width of the freq. comb that can be simultaneously coupled into cavity.

If we have any material in cavity, dispersion of medium will make modes not evenly spaced.

Dielectric mirrors have wavelength dependent phase shifts which also cause modes spacing to vary

Ultrafast lasers often use mirrors with mirrors designed to cancel the dispersion of the gain medium.

Some Uses for Optical Cavities in Spectroscopy

- Control frequency and linewidth of lasers
- Monitor laser scan for calibration
- Laser linewidth is reduced by locking on to the transmission peak of a cavity
- Cavities are used to build up intensity
 - External c.w. second harmonic generators
 - Pump extremely weak transitions
- Used to enhance optical absorption

Review of Absorption of Light

$$I_{out}(\nu) = I_{in}(\nu) \cdot \exp(-\alpha(\nu)L) \quad \text{Beer-Lambert Law}$$

$$\alpha(\nu) = N_g \cdot (1 - \exp(-h\nu/kT)) \cdot \sigma(\nu)$$

$$\sigma(\nu) = \frac{2\pi^2 \mu_{ge}^2}{3\epsilon_0 hc} \cdot \nu \cdot g(\nu - \nu_{01}) = \frac{A_{01} \lambda^2}{8\pi} \cdot g(\nu - \nu_{01})$$

$$\int g(\nu - \nu_{01}) d\nu = 1 \rightarrow g(\nu_{01}) \approx \frac{1}{\Delta\nu_{FWHM}}$$

$$S = \int \sigma(\nu) d\nu = \frac{A_{01} \lambda^2}{8\pi}$$

Electronic vs. Vibrational

- $\mu = 10$ Debye
 - $\nu \sim 50,000 \text{ cm}^{-1}$
 - $A = 10^8 \text{ s}^{-1}$
 - $S = 10^{-13} \text{ cm}$
 - $\Delta\nu(\text{liquid}) = 10^4 \text{ cm}^{-1}$
- 0.1 Debye
 - $\nu \sim 1000 \text{ cm}^{-1}$
 - $A = 1 \text{ s}^{-1}$
 - $S = 10^{-18} \text{ cm}$
 - $\Delta\nu(\text{liquid}) = 10 \text{ cm}^{-1}$

Sub-Doppler resolution infrared spectroscopy of vibrationally hot molecules

H.K. Srivastava, A. Conjusteau, H. Mabuchi, A. Callegari, K.K. Lehmann, and G. Scoles, Rovibrational spectroscopy of the $v=6$ manifold in $^{12}\text{C}_2\text{H}_2$ and $^{13}\text{C}_2\text{H}_2$, *J. Chem. Phys.* **113**, 7376-7383 (2000).

Experimental Apparatus

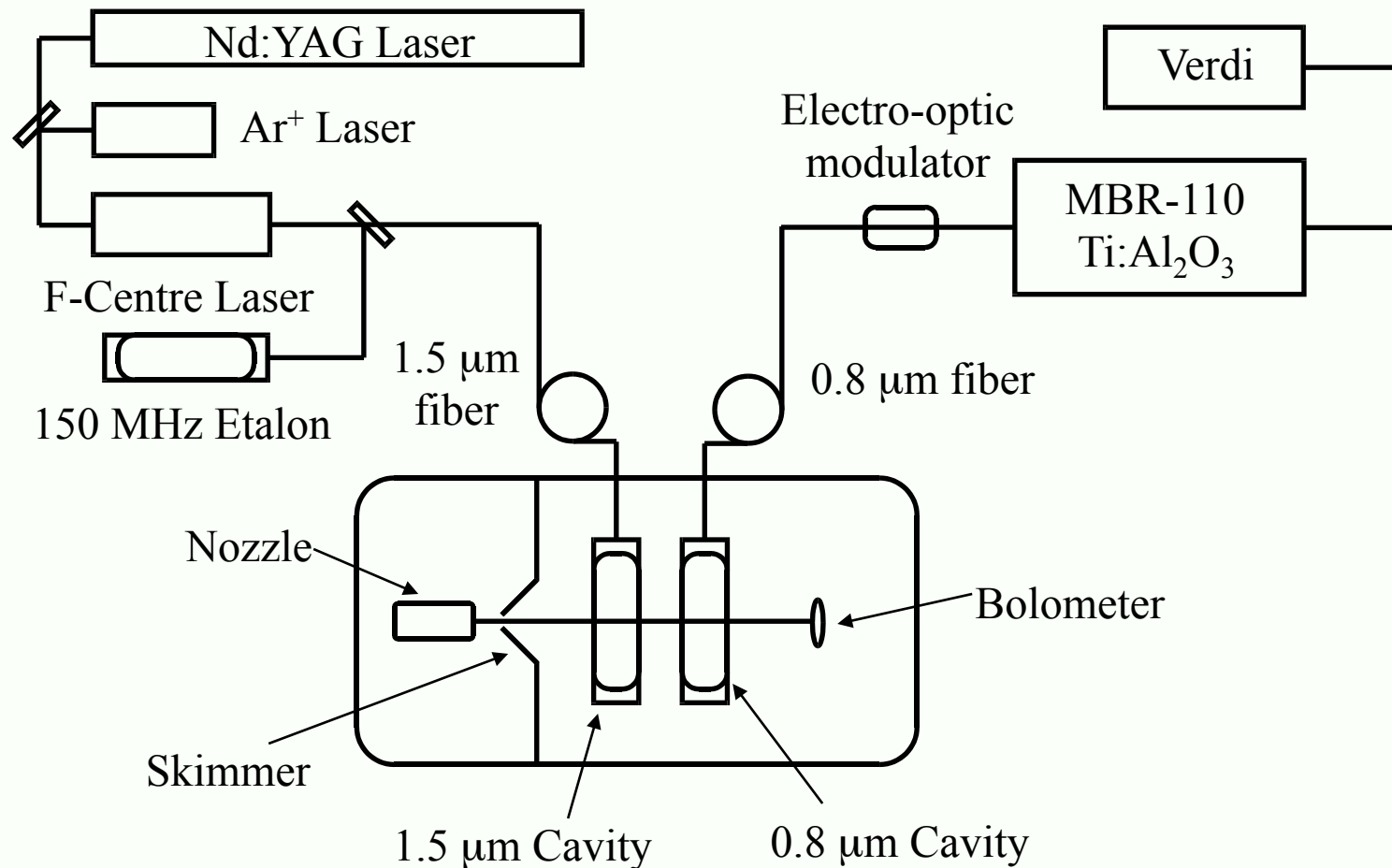

Double Resonance

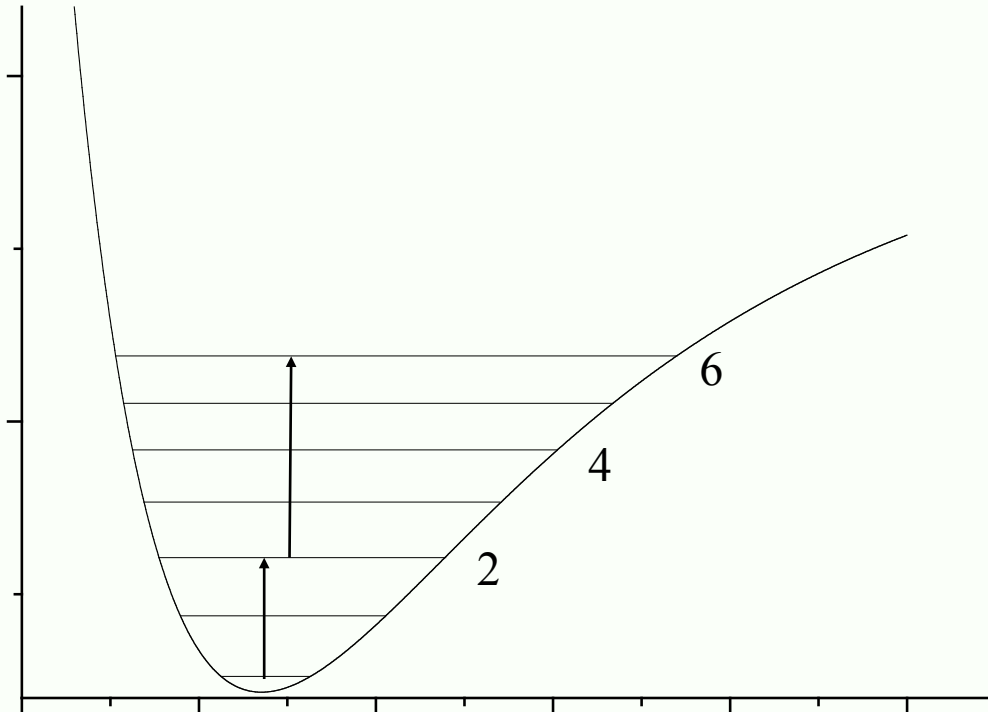

Transition	Saturation Power (W)
$0 \rightarrow 2$	1
$0 \rightarrow 4$	600
$0 \rightarrow 6$	48 000
$2 \rightarrow 6$	50

- The anharmonicity of the $v=2$ level means that we need much less laser power to see the $2 \rightarrow 6$ transition than the $0 \rightarrow 4$ or $0 \rightarrow 6$ transitions

Potential energy “surface”

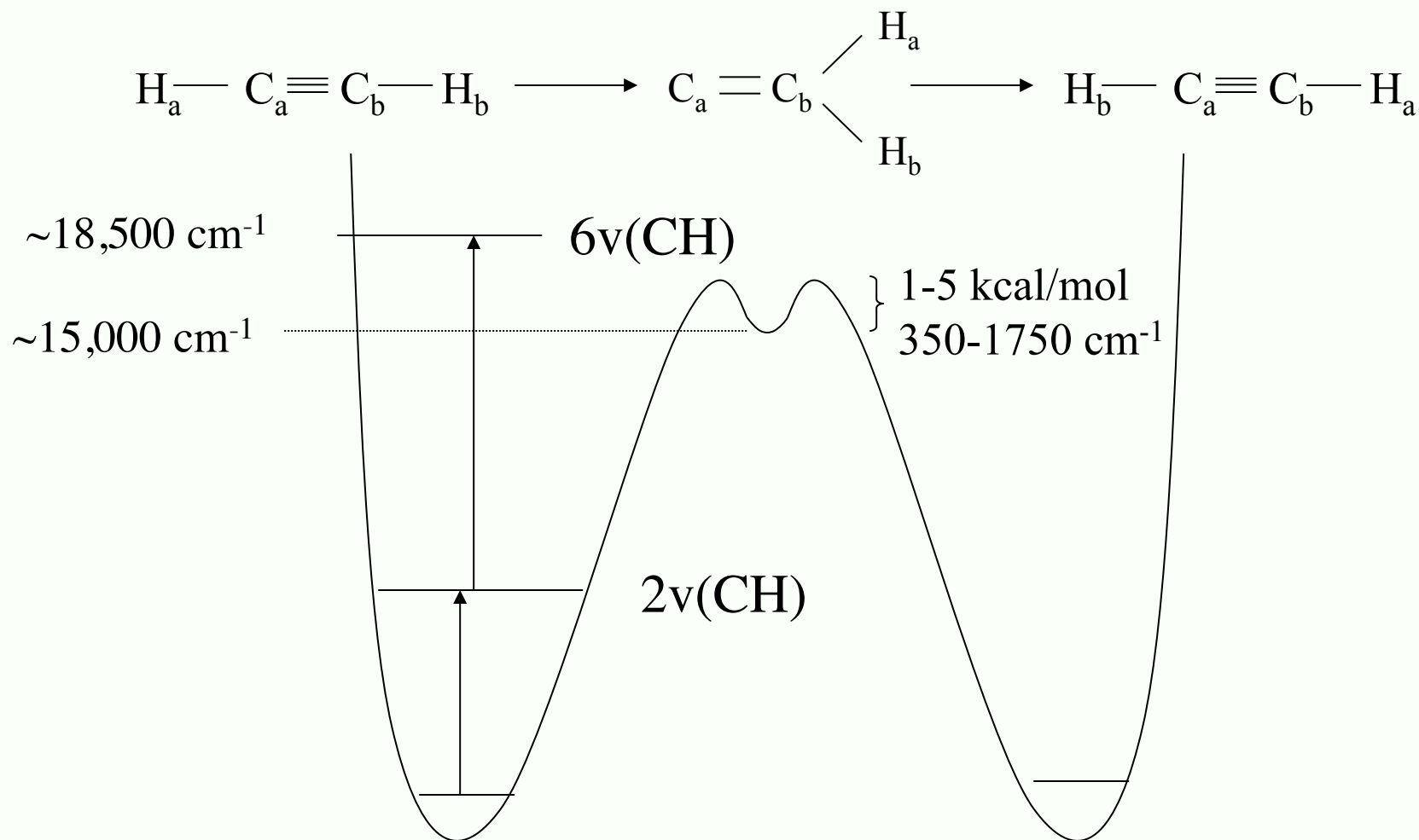

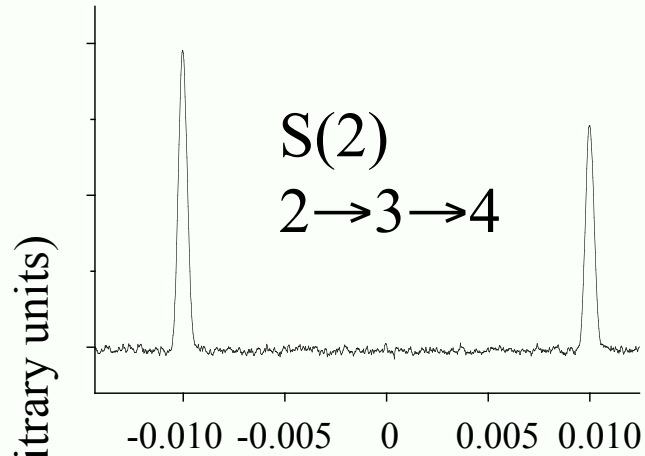

Transition	Splitting (cm ⁻¹)	Intensity Ratio
S(2) 2 \rightarrow 3 \rightarrow 4	.021	1.4
Q(4) 4 \rightarrow 5 \rightarrow 4	.019	1.8

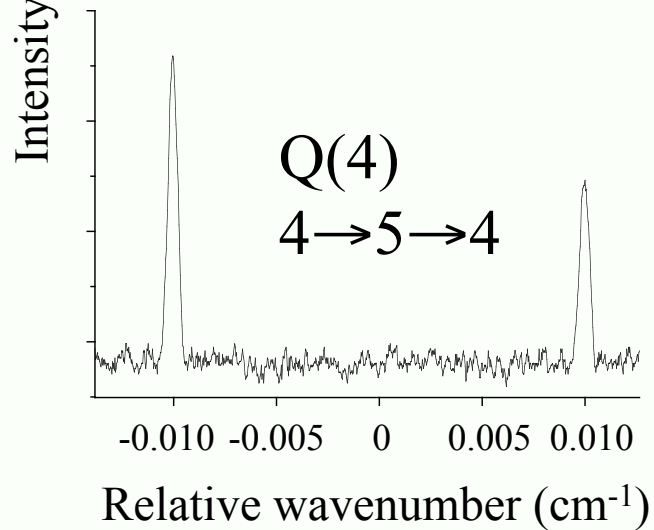

Transitions \sim 30 MHz FWHM

Did not observe tunneling splitting \rightarrow rate $< 10^7$ s⁻¹
 $> 10^4$ times slower than prediction of RRKM theory

Real-time detection of individual atoms falling through a high-finesse optical cavity

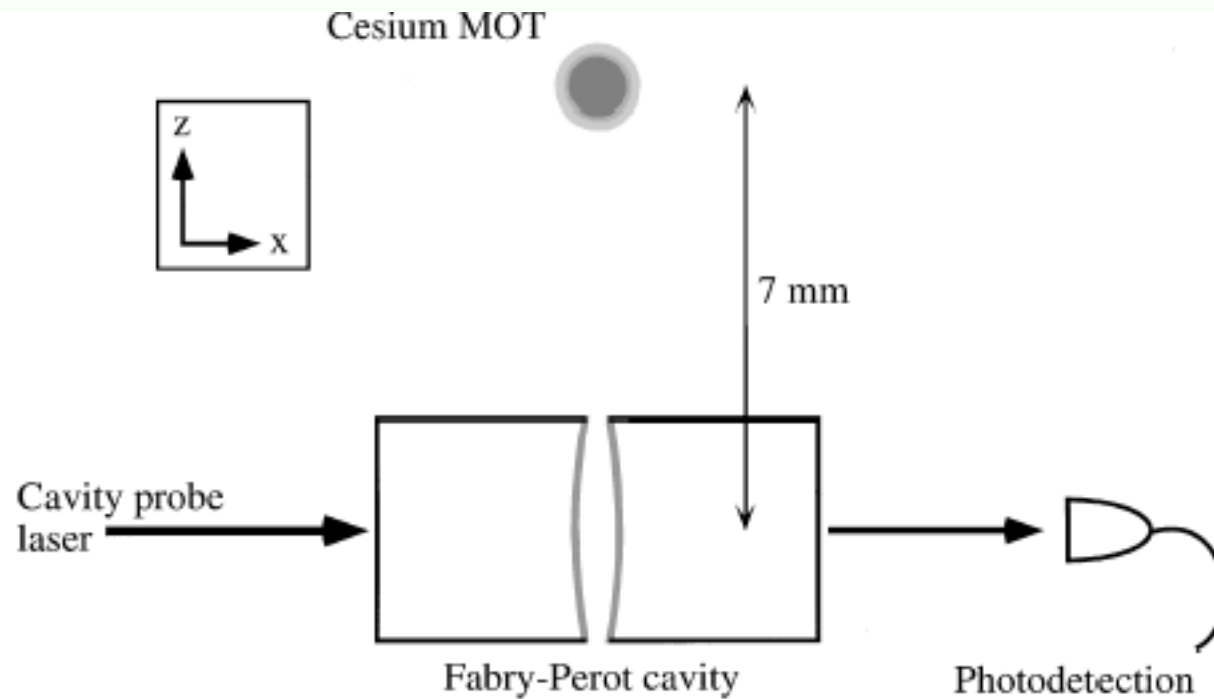

Fig. 1. Schematic diagram of the experiment. The cesium MOT lies 7 mm above the cavity axis, the mirror substrate diameter is 3 mm, and the cavity length is $108 \mu\text{m}$.

$1-R = 15 \text{ ppm}$ for Mirrors used

H. Mabuchi *et al.*, Optics Letters **21**, 1393 (1996)

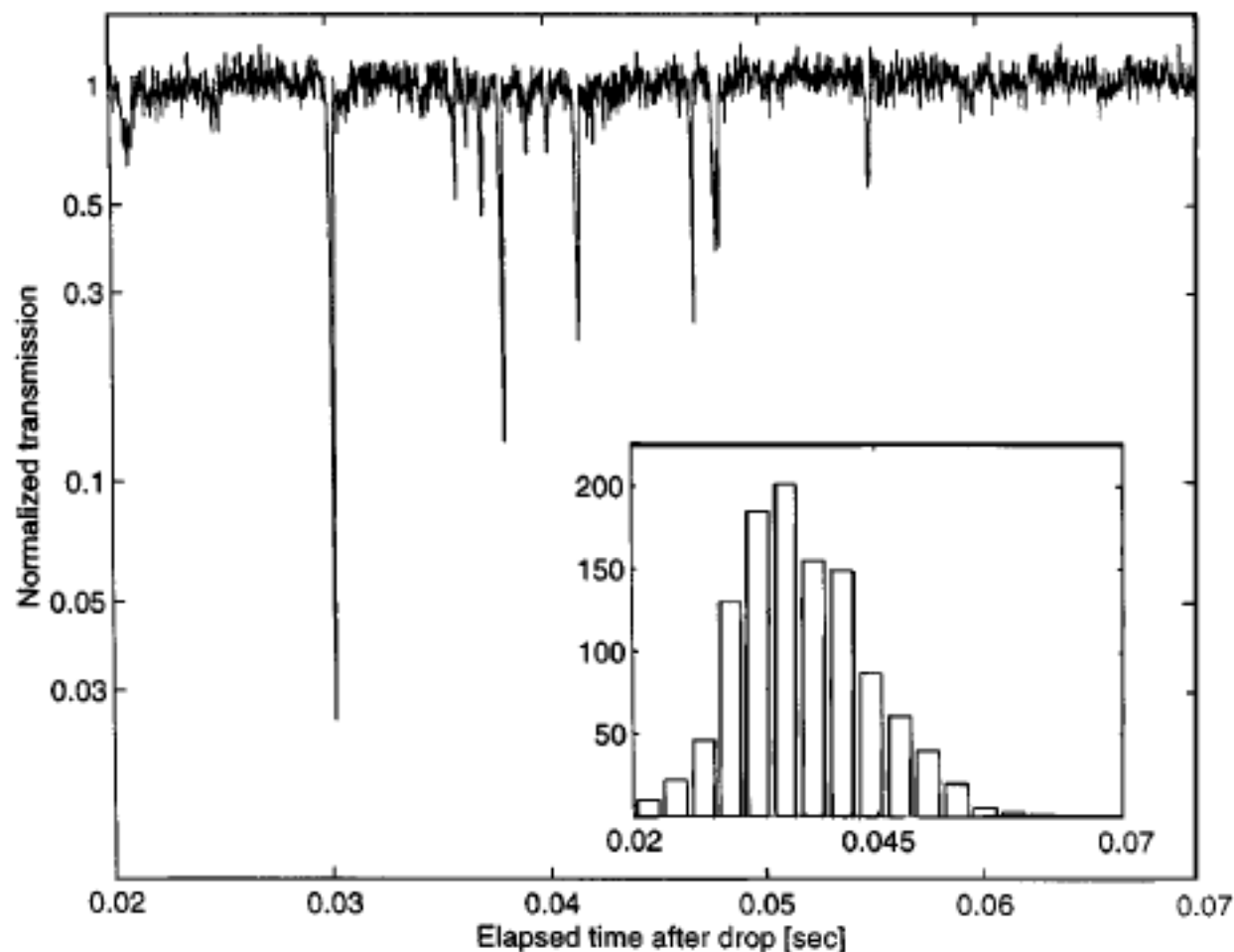

Fig. 2. Time-varying cavity transmissions after a cesium MOT is dropped, normalized to probe power P_0 transmitted through the empty cavity. For these data P_0 corresponds to ≈ 2 photons in the empty cavity, and $\omega_A = \omega_C = \omega_L$ (see text). Inset: histogram of atom arrival times compiled from 450 consecutive trap-drop cycles.

Trace Species Detection

- Need high Sensitivity
- Need high Selectivity
- Maximize Speed of response
- Minimize Sample preparation
- Minimize Cost
- Maximize Reliability

Spectroscopic Methods for trace detection

- Ionization & time of flight mass spect.
 - Most sensitive if can be saturated since one can detect every single ion produced.
 - Requires high vacuum.
 - Fragmentation can compromise selectivity
- Laser Induced Fluorescence
 - Can detect single molecules in some cases
 - Requires good emission yield.
- Absorption based techniques
- Photoacoustic and other thermal methods.
- Transient Grating techniques (CARS)

Sensitivity Limits in Absorption Spectroscopy

$$\alpha_{shot_noise} = \frac{1}{Path_Length} \sqrt{\frac{h\nu}{Intensity}}$$

Real Lasers have orders of magnitude higher amplitude noise at low frequency. However, they often come close to shot noise limit for detection frequencies above ~10-100 MHz

How can we modulate absorption at such high frequencies?

Frequency Modulation (FM) spectroscopy

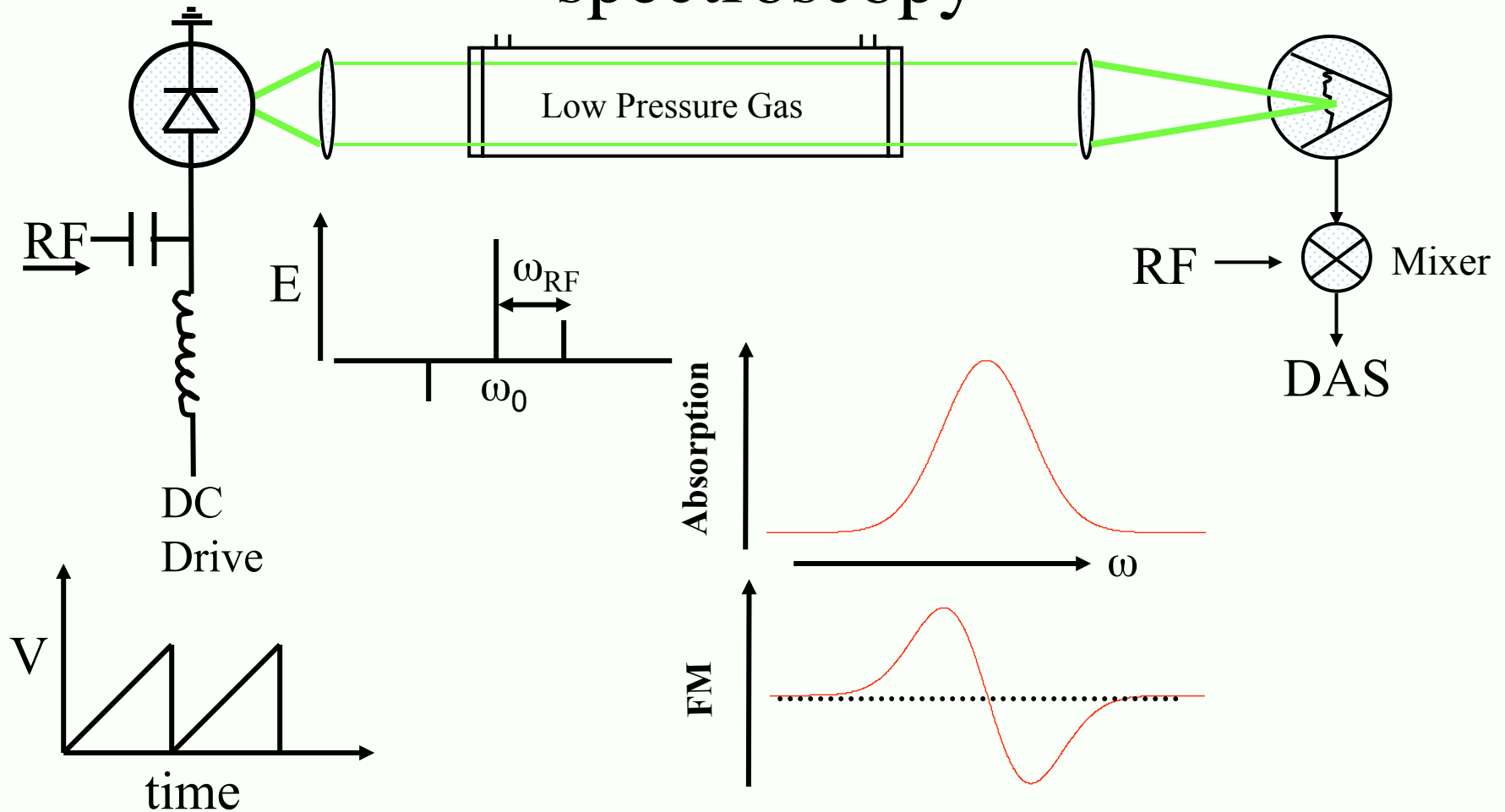

FM spectroscopy

- Requires fast detector (reduces sensitivity)
- Fastest response, can measure absorption in nsecs (used for transient species)
- Measures derivate of spectrum, which reduces sensitivity for broad lines by ratio of $\Delta\nu$ / optical transition linewidth.
- Real phase modulators introduce small amplitude modulation as well, introducing low frequency noise of laser into detection
 - Can be removed in some cases by double modulation.

Can we use optical cavities to improve sensitivity for absorption ?

- Transmission of cavity decreases by $\sim 2-4$ times if loss per pass equals mirror loss, which can be ~ 10 ppm.
 - Transmission is very noisy unless laser linewidth is \ll band pass of cavity ($\sim 1/2\pi\tau$)
 - Easier to excite cavity and measure decay time of cavity-- Cavity Ring-Down
- ## Common Optical Filters

Cavity Ring-Down Absorption Spectroscopy

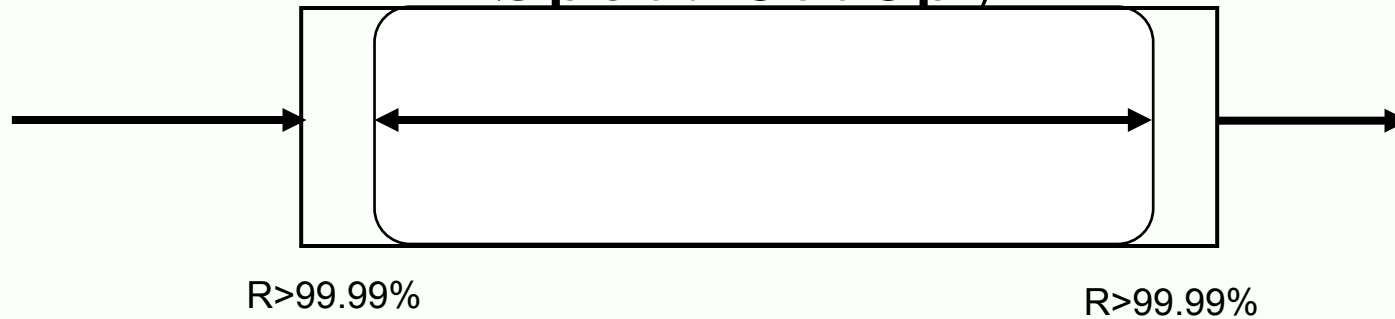

Absorption

$$I(t) = I_0 \exp\left[-t\left(\frac{c}{L} \ln R + c \cdot \sigma(\lambda) \cdot N\right)\right]$$

$$L_{\text{eff}} = L / (1 - R)$$

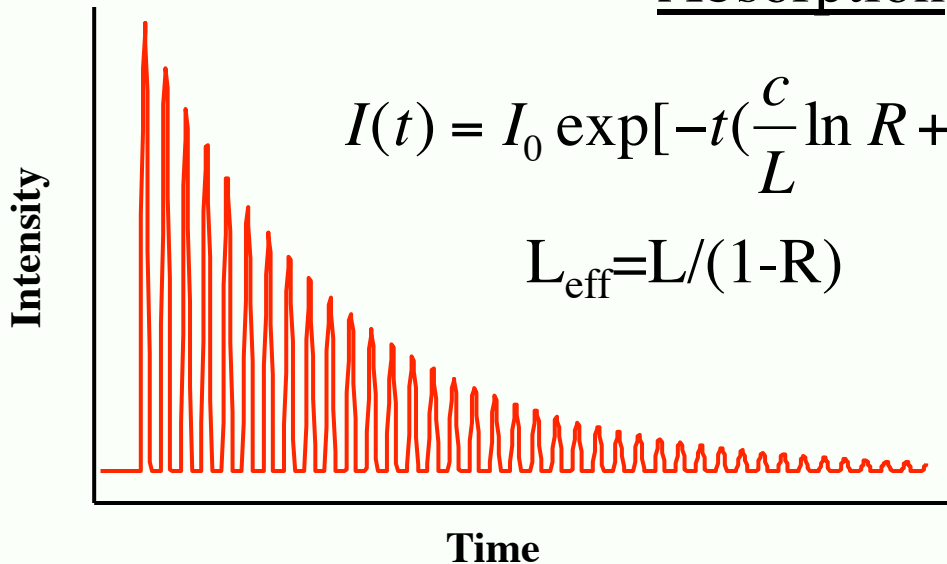

Where:

c : speed of light

L : length of cavity

R : mirror reflectivity

σ : absorption cross section

N : number density (concentration)

L_{eff} : effective pathlength

Cavity Ring-Down Decay

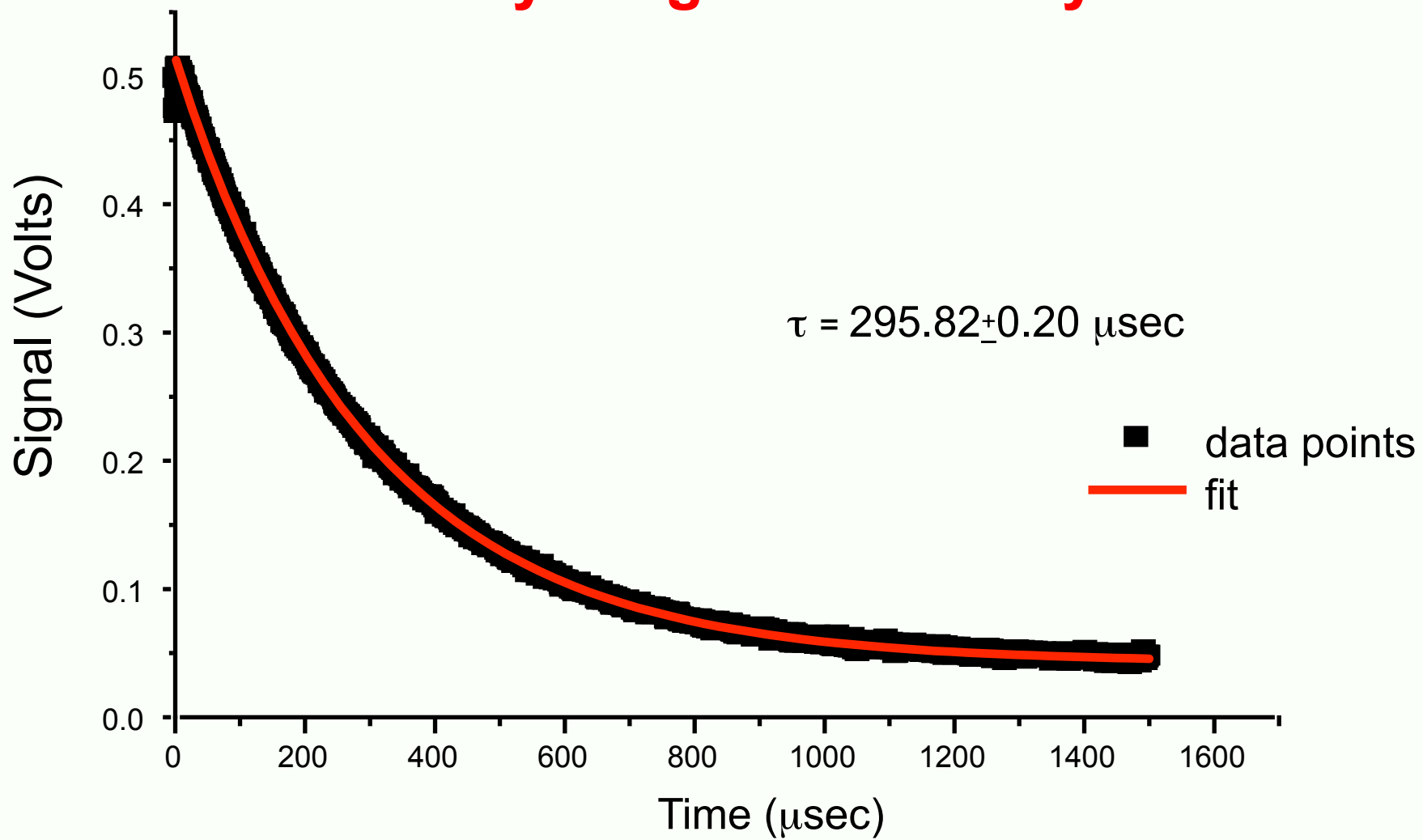

Ring Down Cavity Technique

First Developed by O'Keefe and Deacon
Rev. Sci. Instr. 59, 2544 (1988)

Theory: Romanini and Lehmann
J. Chem. Phys. 99, 6287 (1993)

- Use a passive optical cavity formed from two high reflective mirrors ($T \sim 1-100$ ppm)
- Excite cavity with a pulsed laser to 'fill' with photons
- Detect exponential decay of light intensity inside resonator
- Decay rate reflects:
 - Loss due to mirrors (slowly changing with wavelengths)
 - Absorption of gas between mirrors

Advantages of Ring Down Cavity Method

- RDC allows much longer pathlengths than traditional multipass cells
- RDC only sensitive to loss between mirrors
- Beer's Law holds for all pathlengths; pathlengths determined by time
- RDC cell is very compact; light contained in narrow spot of $\sim 1 \text{ mm}^2$
- RDC cell insensitive to vibration since it is a stable optical cavity
- Amplitude noise of laser not important
- Light can be coupled in and out with optical fibers
- Simple and low cost compared to ICLAS

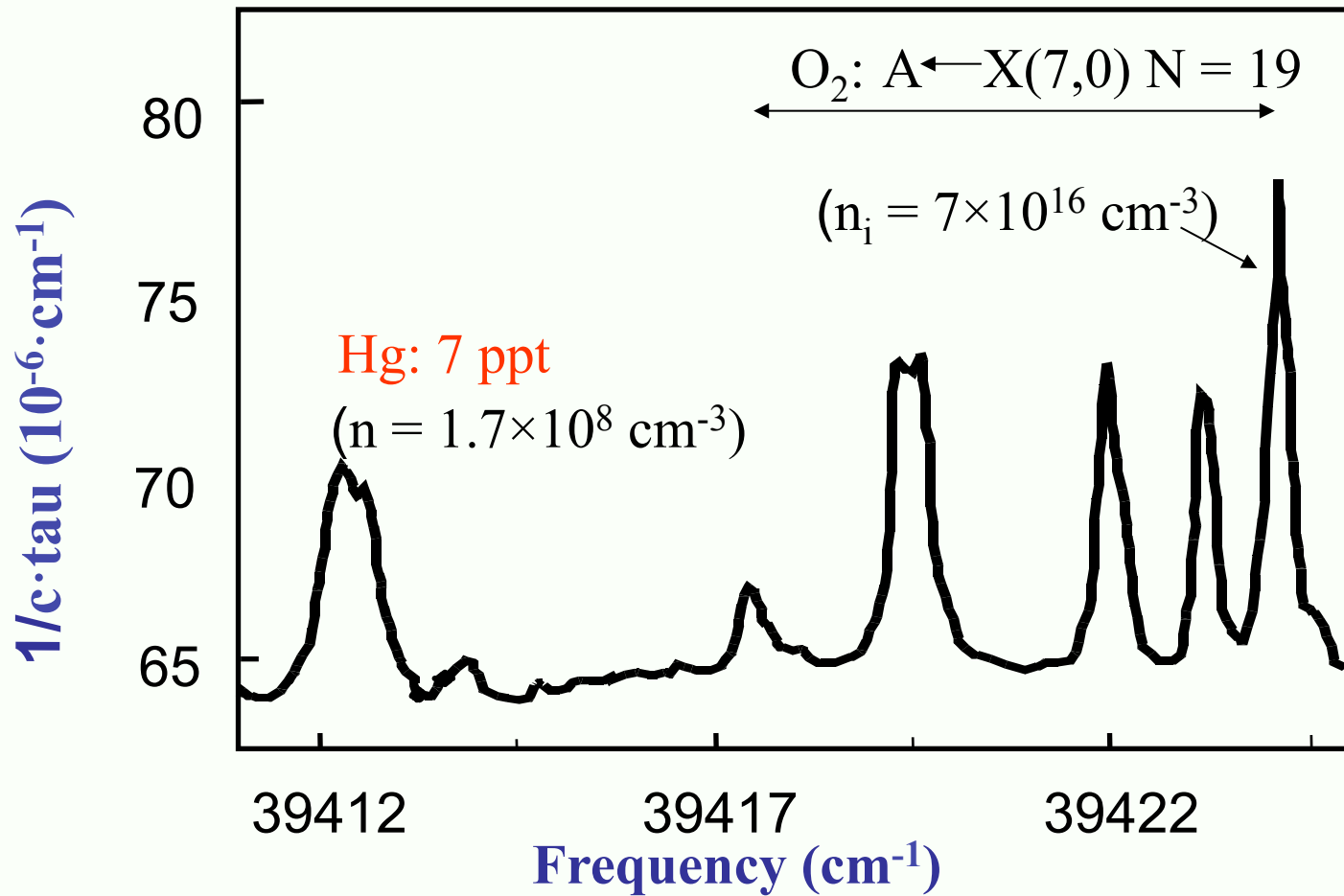

Trace gas detection with cavity ring down spectroscopy

Rienk T. Jongma, Maarten G.H.Boogaats, Iwan Holleman, and Gerard Meijer

Department of Molecular and Laser Physics, University of Nijmegen, Toernooiveld, 6525 ED, Nijmegen, The Netherlands

Diode Laser Advantages

- Low cost, compact, all solid state
- Low power requirements
- Wide electronic frequency tuning
- Single mode diodes in the near-IR are becoming available for sensing apps.
 - H₂O, C₂H₂, CH₄, CO₂, NO₂, NH₃, etc.

Other Advantages of c.w. Excitation:

- **Observe cavity decays at much higher rate ($\sim 1-10$ kHz), reduces dynamic range of detection system**
- **Couple only one resonate mode of cavity**
- **Increased spectral resolution**
 - **Time of flight through laser focal spot ~ 100 kHz**
- **Light intensity inside cavity increased $\sim 10^4 - 10^5$**
 - **Calculations indicate that we should be able to saturate allowed Doppler free two photon transitions**
- **Diode lasers greatly reduces system cost and size**

Stability of Ring-Down Rates

Ensemble Standard Deviation:

10 pts:	201.384 ±0.139 μs	0.069%
100 pts:	201.378 ±0.165 μs	0.082%
1000 pts:	201.304 ±0.146 μs	0.073%

This translates, with averaging ~ 100 decays, to a noise equivalent Absorption of $\sim 10^{-11} \text{ cm}^{-1}$ or 1 part per billion per pass of cell.

This is still a couple orders of magnitude above theoretical limits.

A commercial trace gas instrument was developed with Tiger Optics

Variations on CRDS Method

- CRDS (a.k.a. CRLAS, RDCS, cavity leak-out spectroscopy)
 - pulsed CRDS
 - cw CRDS
 - phase shift CRDS
 - Fourier Transform CRDS
 - broad band CRDS
 - evanescent wave CRDS
 - fiber optic CRDS, fiber loop CRDS
 - Cavity Ring-down polarimetry
 - Optical feedback CRDS
 - Saturation absorption CRDS (SCAR)

- Cavity Enhanced Absorption Spectroscopy (CEAS)-Engleln, Meijer, *et al.*
 - a.k.a Integrated cavity output spectroscopy (ICOS) - O' Keefe
 - Frequency chirped CEAS
- Noise Immune Intracavity optical heterodyne method (NICE-OHMS)
- Intracavity laser absorption spectroscopy (ICLAS)
- Intracavity photoacoustic spectroscopy
 - attractive with optical locking!

Excellent Review: C. Vallance, *New J. of Chem.* **29**, 869 (2005)

Prism Ring-down Resonator

Output

Input

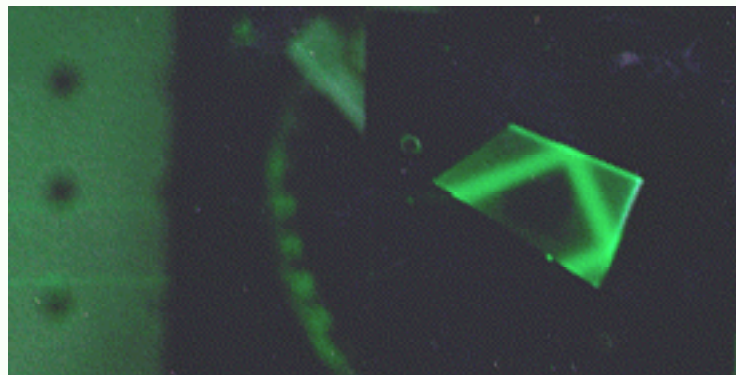
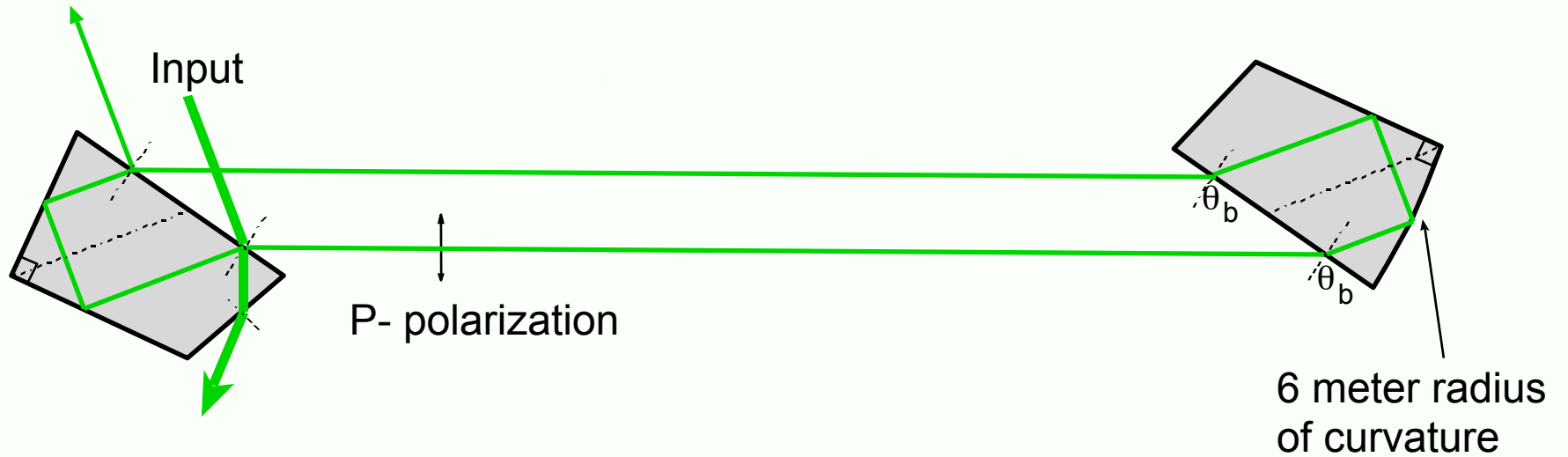

Advantages of Prism Cavity

- **Wide spectral coverage - Simultaneous detection of multiple species**
- **Compact ring geometry (optical isolation)**
- **No dielectric coatings (harsh environments)**
- **Coupling can be optimized for broadband**

Broadband system using white light from photonic crystal fiber

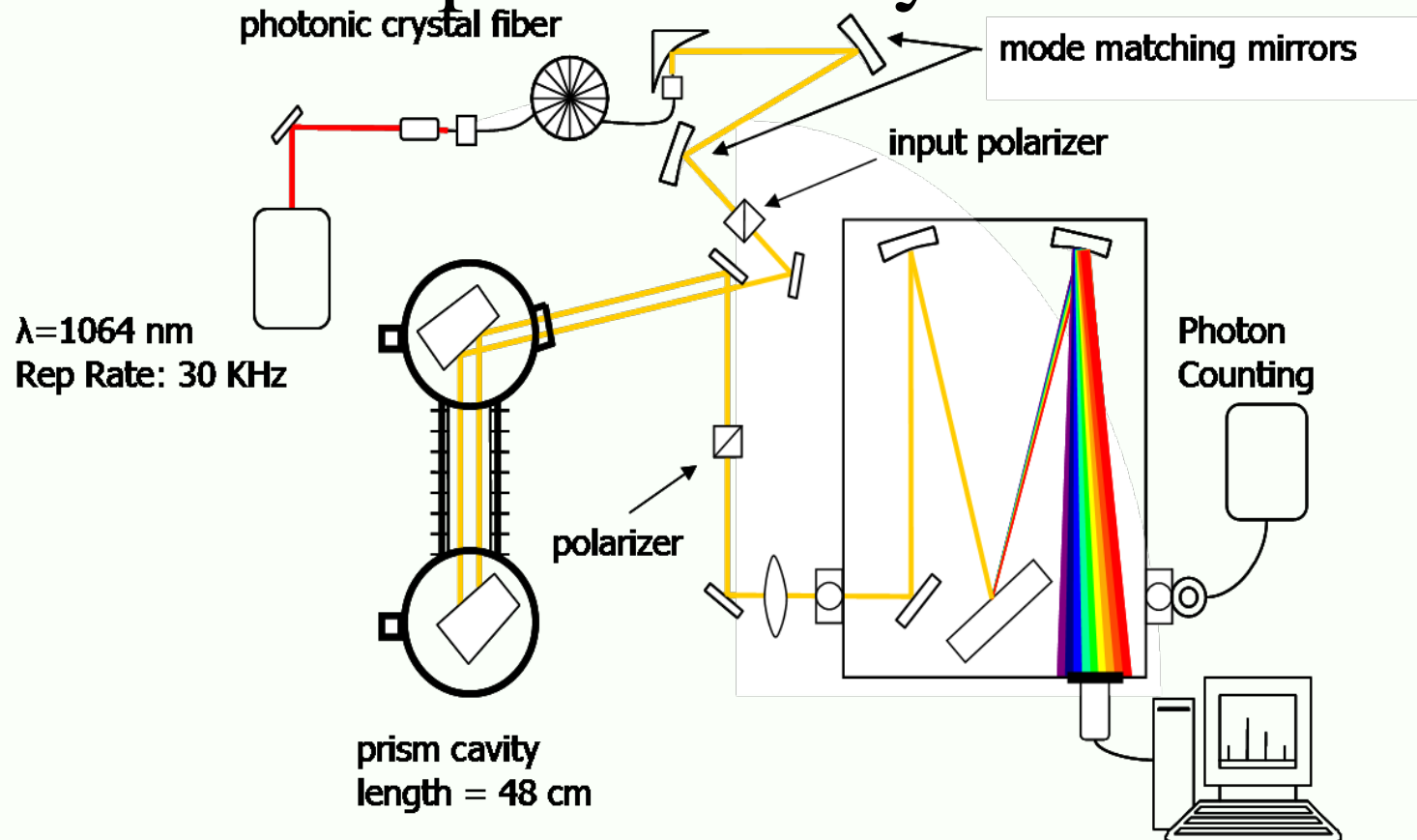
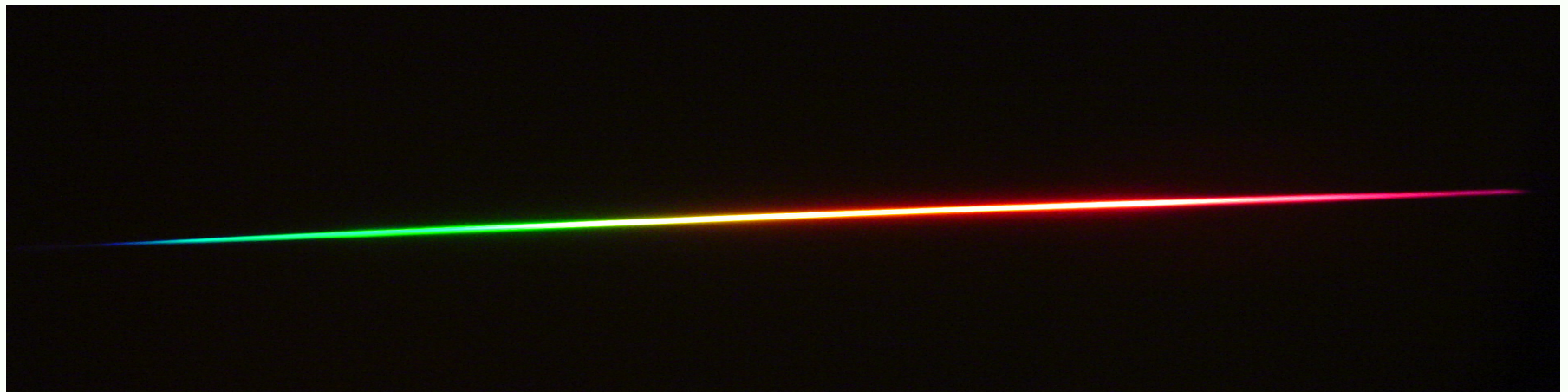

Fig. 1. Schematic of the ultra-broadband cavity enhanced absorption spectrometer showing the major components of the spectrometer: the broadband supercontinuum source, the broadband Brewster's angle retroreflector prism cavity, and dispersive grating spectrograph.

Supercontinuum Output



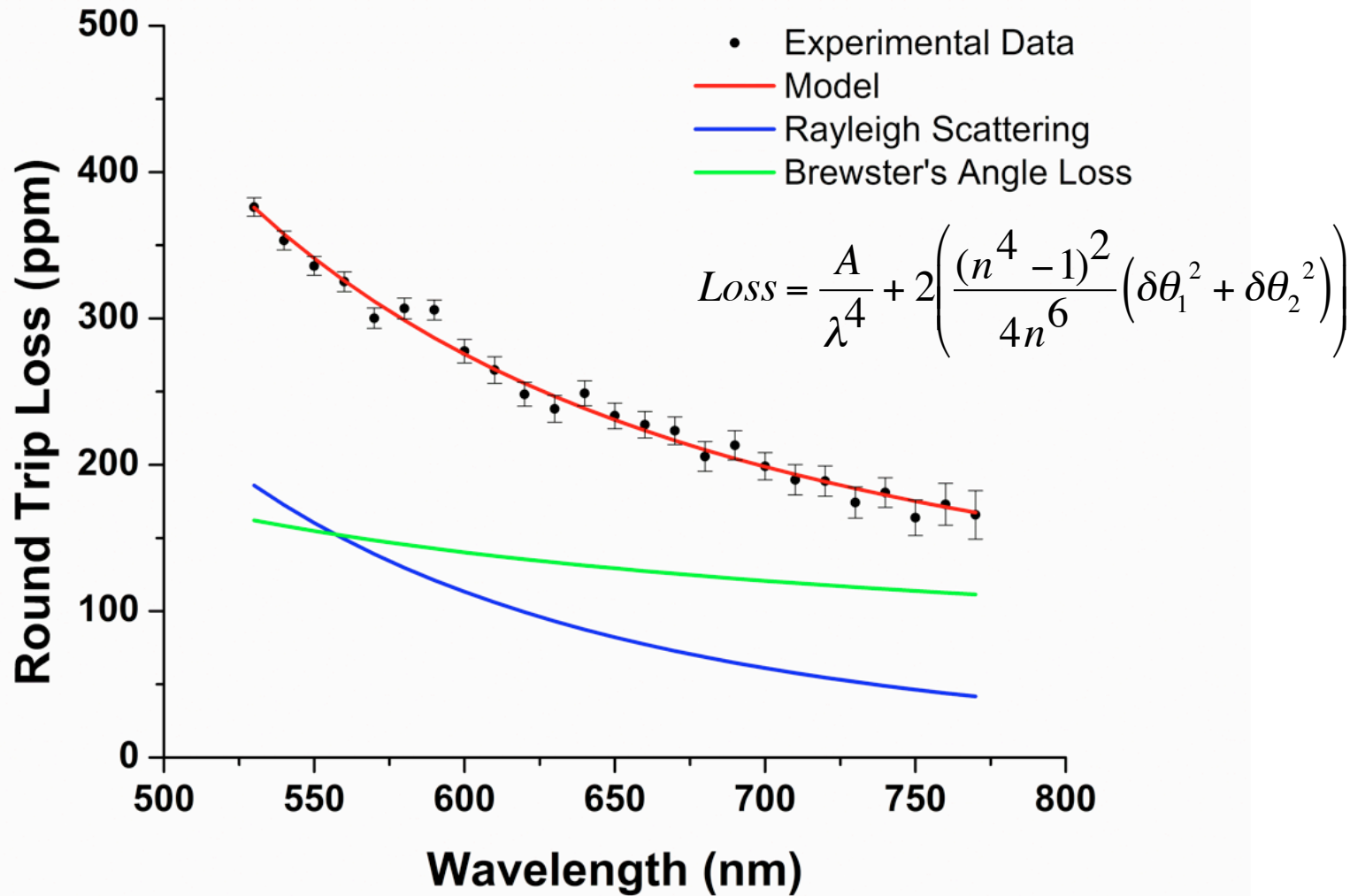

Fig. 6. Observed round trip cavity loss, as determined from the ring-down time, as a function of wavelength, with 2σ error bars from the ring-down fit indicated. Also shown is the Fresnel and scattering loss of the prisms vs. wavelength as determined by a fit of the loss to Eq. 3. The resulting fit parameters are given in the text.

Cavity enhanced spectroscopy

- Measure time integrated intensity

$$\alpha(\nu) = \left(\frac{I_o(\nu)}{I(\nu)} - 1 \right) \frac{1-R}{l}$$

$I(\nu)$ = time integrated intensity with absorbing species

$I_o(\nu)$ = time integrated intensity of empty cavity

- Advantages
 - Relatively high sensitivity
 - Simpler set up
- Sensitivity limitations
 - Residual mode structure
 - Laser noise

Berden, G.; Peeters, R.; Meijer, G. *Int. Rev. Phys. Chem.* **2000**, *19*, 565.

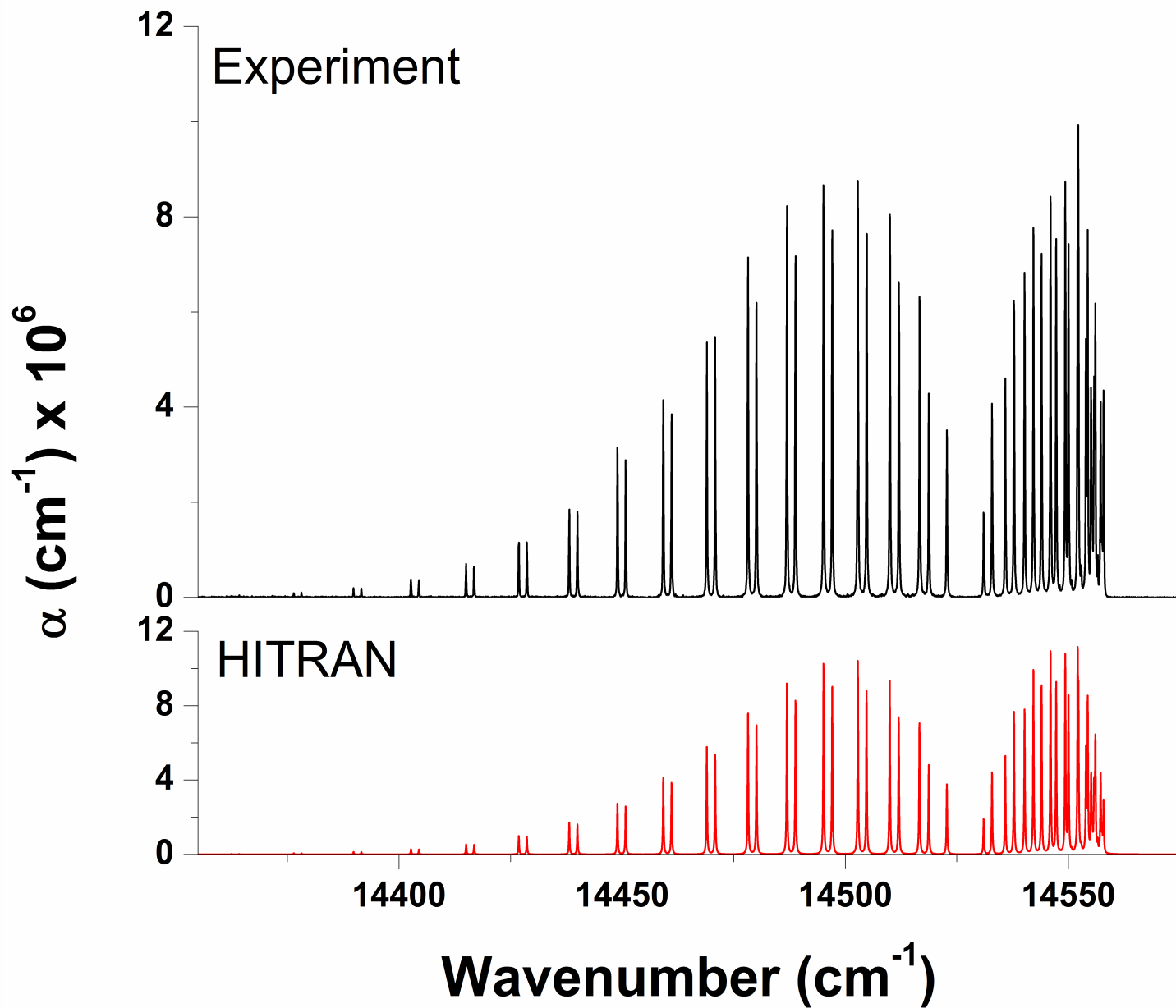

O_2 SPECTRUM IN AIR

Combining FM Spectroscopy with low loss cavities: NICE-OHMS

- Ma, Dube, and Hall, *JOSA B* **16**, 2255 (1999)
- Use extremely narrow linewidth laser such that most light is coupled into cavity
- Put side bands a spacing to exactly match cavity free spectral range.
- Detect modulation in cavity transmission.

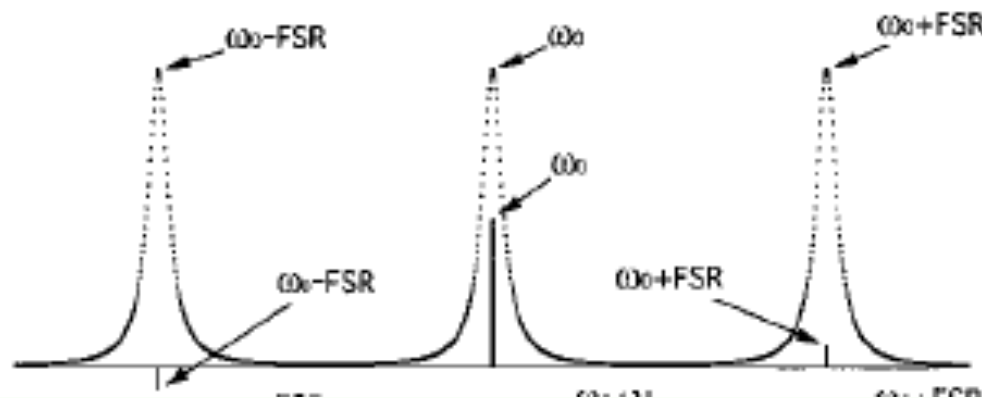

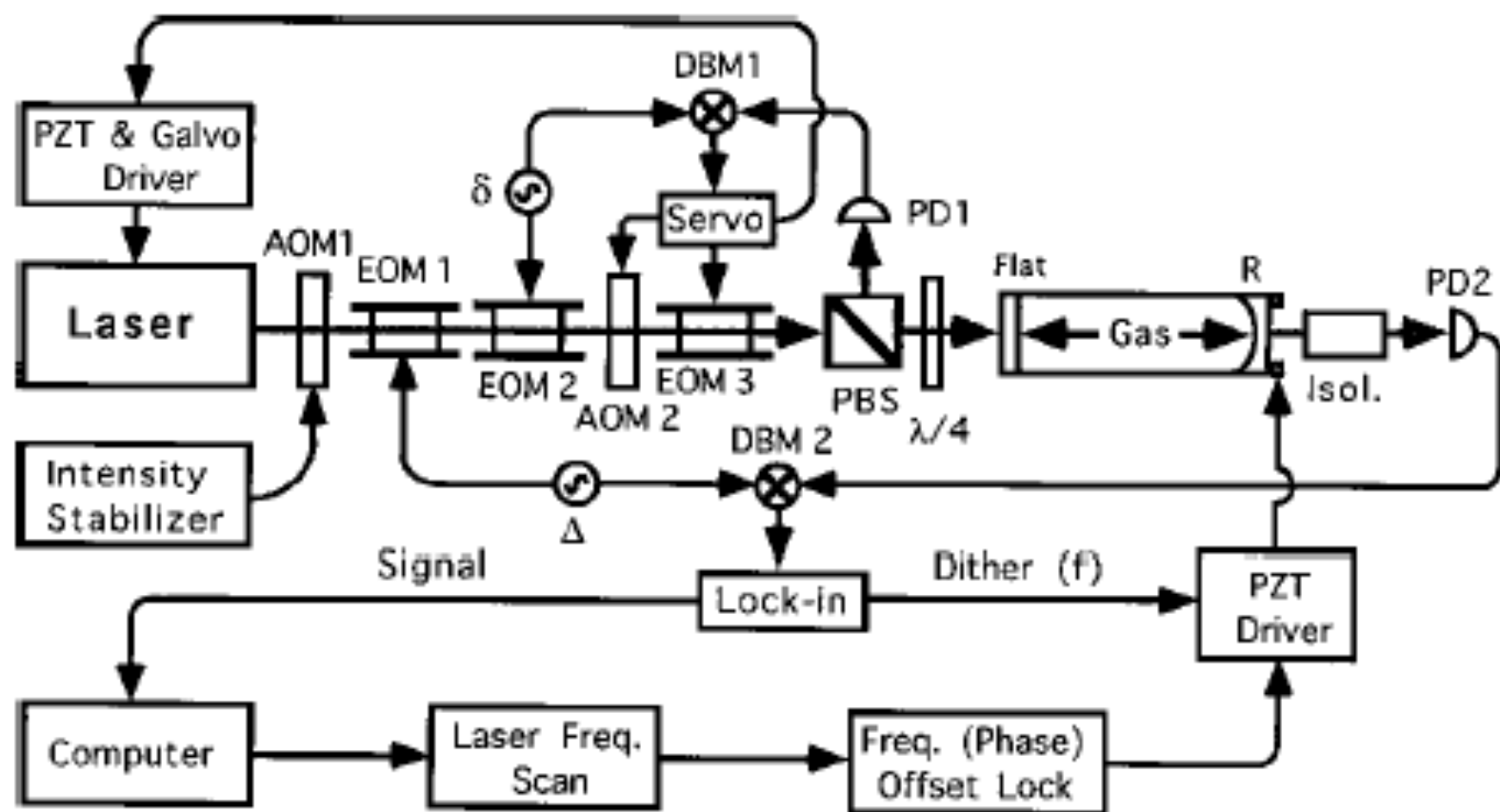

Fig. 5. Experimental configuration for NICE-OHMS. An external stabilizer (AOM-EOM) is employed to widen the frequency servo bandwidth. Sidebands at $\delta/2\pi = 4$ MHz are used for reflection lock to cavity; sidebands at $\Delta =$ cavity FSR are used in transmitted light as local oscillators for heterodyne detection of saturated gas absorption inside the cavity. DBM's, double-balanced mixers; PD's, photodiodes; R, concave reflector; other abbreviations defined in text.

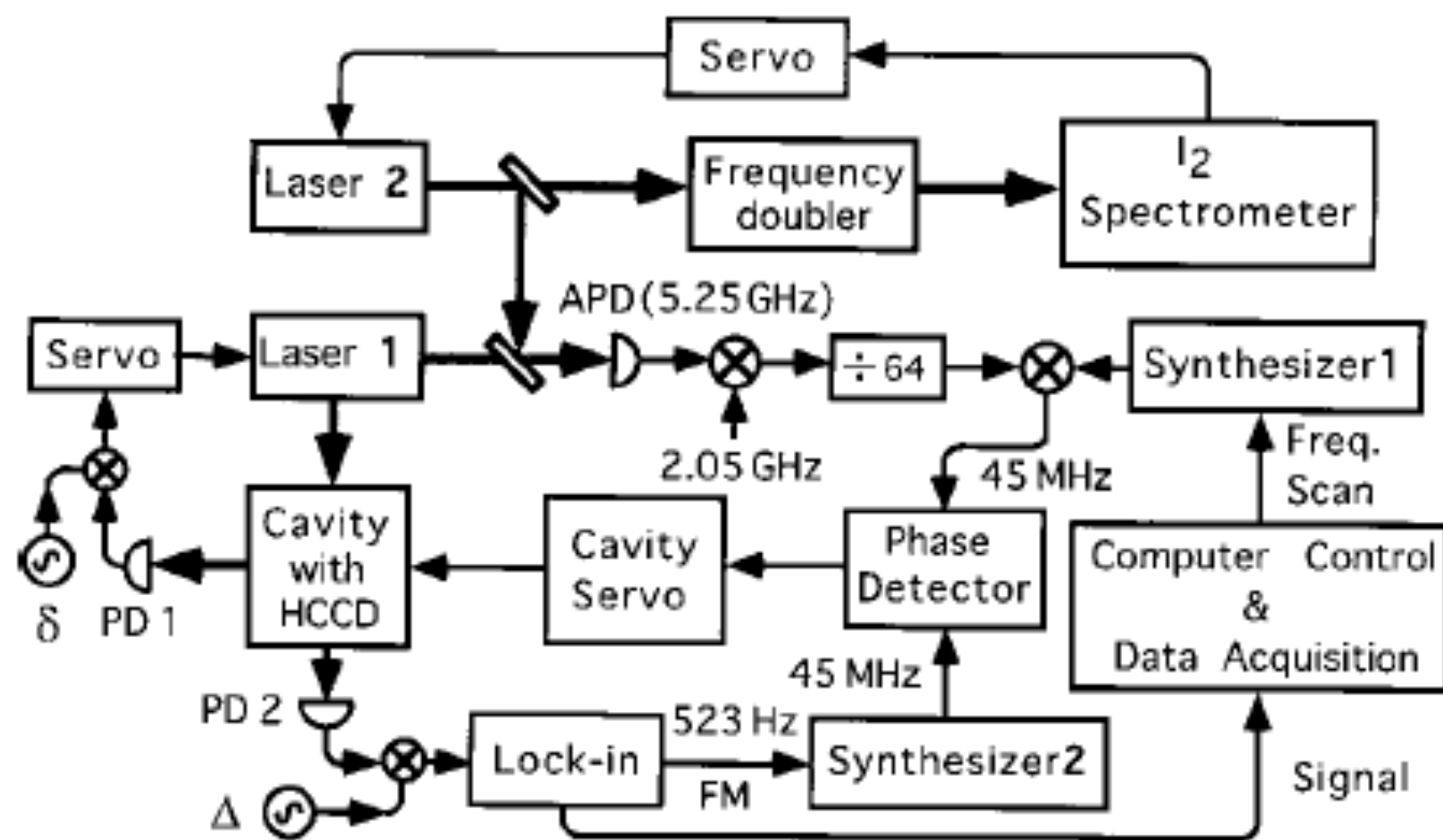
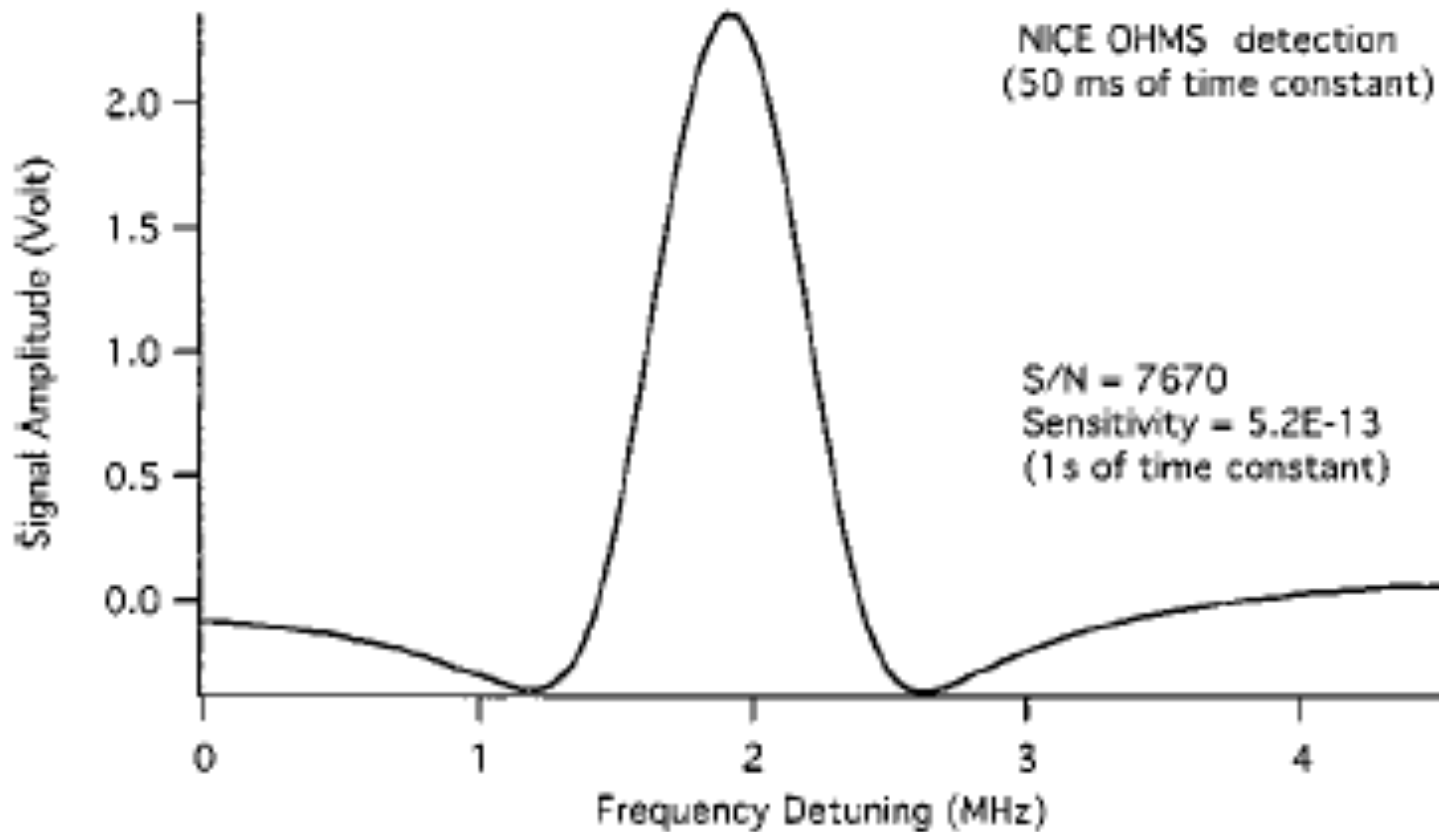

Fig. 6. Precision scanning NPRO-HCCD spectrometer, referenced to an I₂-stabilized NPRO. rf offset between the two laser systems is implemented by a phase-locked loop. PD's, photodiodes; APD, avalanche photodiode.

Lamb Dip of $\nu_2+3\nu_3$ transition of HCCD 10^{-6} times as strong as C-H IR fundamental



$$\alpha_{noise} \approx 1 \cdot 10^{-14} \text{ cm}^{-1} / \sqrt{\text{Hz}}$$

Only 30% above shot
noise limit!

Intracavity laser absorption spectroscopy

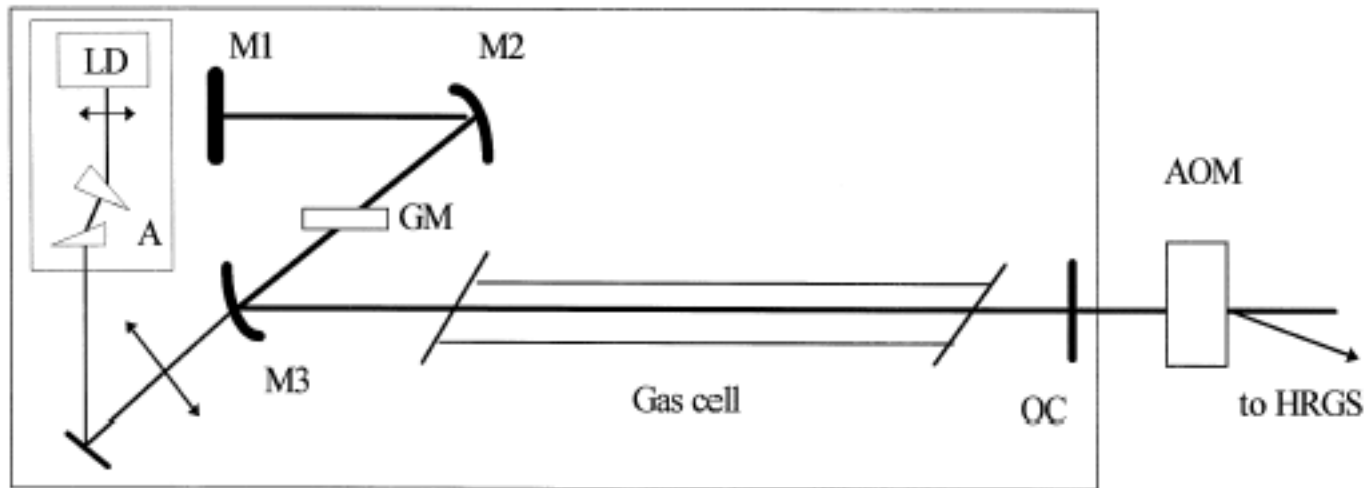

Sample spectrum of light t_g after laser pumping is started. Spectrum will show gain narrowing and absorption from narrow Absorption peaks. Effective pathlength = $c t_g \times$ fill factor.

Maximum t_g limited by mode coupling and spontaneous emission. For low gain solid state lasers, $t_g \sim 10$ ms can be used.

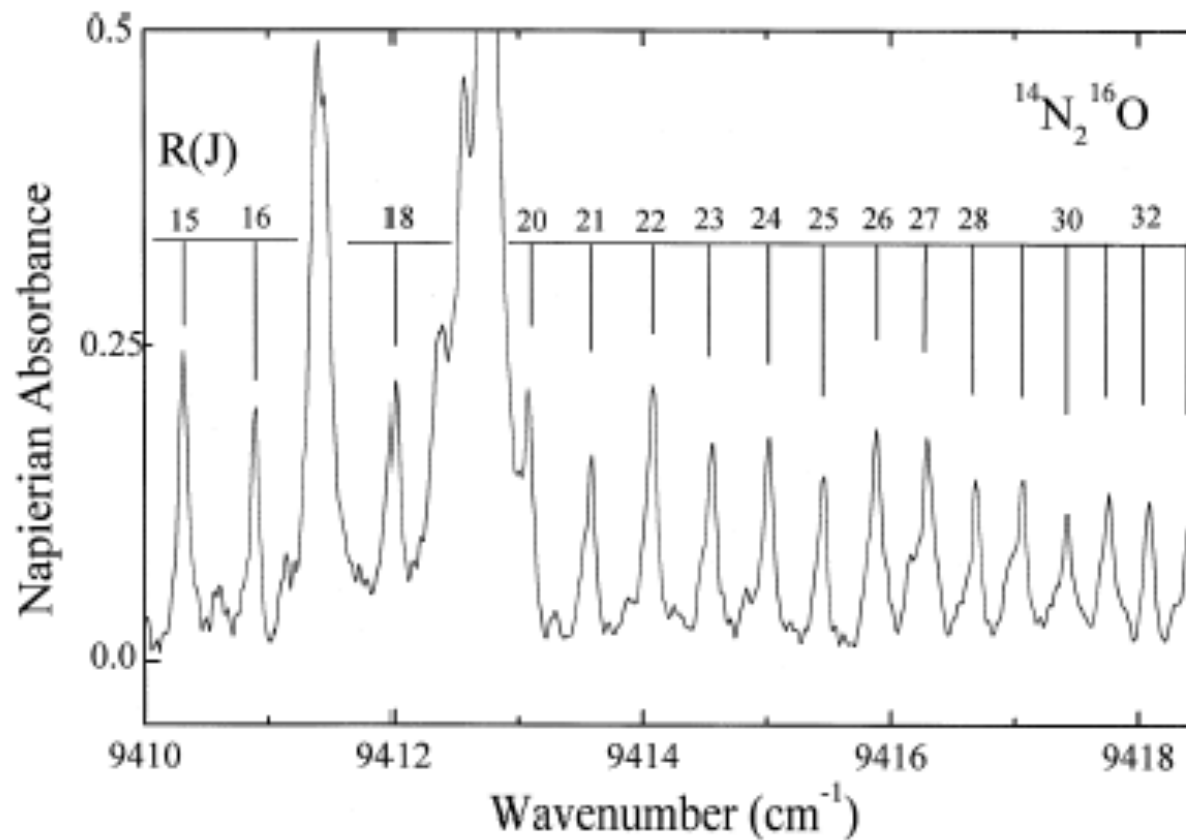

$$t_{\text{gs}} = 500 \mu\text{s} \quad \text{Pathlength} = 60 \text{ km} \quad \alpha(\text{min}) = 10^{-9} \text{ cm}^{-1}$$

A. Garnache, A. Campargue *, A.A. Kachanov, F. Stoeckel
 Chemical Physics Letters 292 (1998) 698–704

CRDS vs. ICLAS

- **Both use long effective pathlengths**
- **Beer's Law holds only approximately for ICLAS**
- **ICLAS has higher noise, but detects many wavelengths at once.**
- **ICLAS requires laser integrated as part of detection system**

CRDS vs. ICLAS

- **ICLAS requires:**
 - **Broad bandwidth laser**
 - **Very high resolution spectrograph**
 - **Array detector**
 - **Can only detect 'narrow' spectral**
- **CRDS requires:**
 - **Very high reflective mirrors**

Dual Etalon Frequency Comb (DEFCOMB) Cavity Ring Down Spectroscopy

David W. Chandler and Kevin E. Strecker
Sandia National Labs

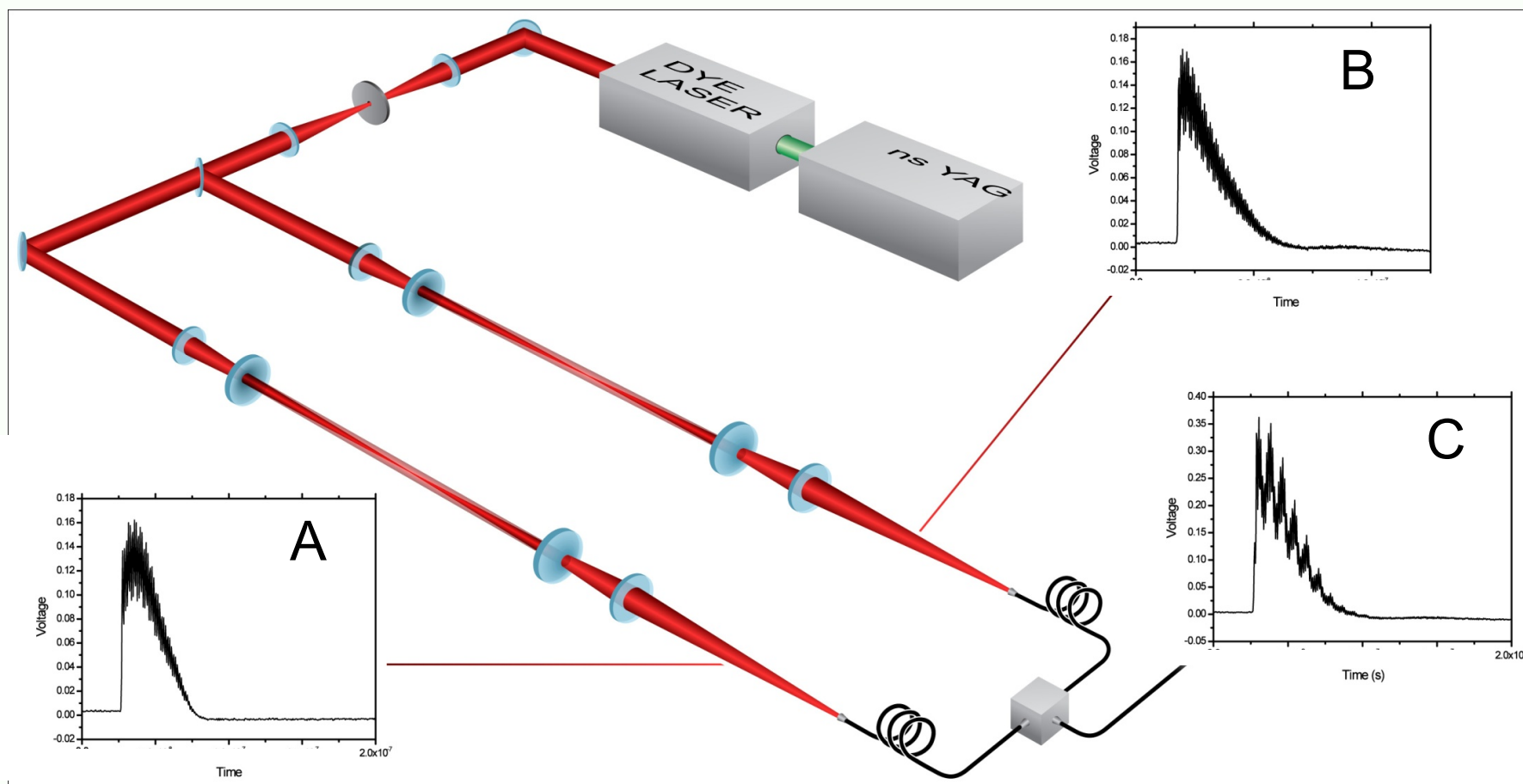

Schematic of How Dual Etalon Frequency Comb (DEFComb) Apparatus Works. Many Versions are Possible!

Use two ~300 MHz etalons and a 2 GHz Dye laser (or OPO, or ASE, or Femtosecond pulse)

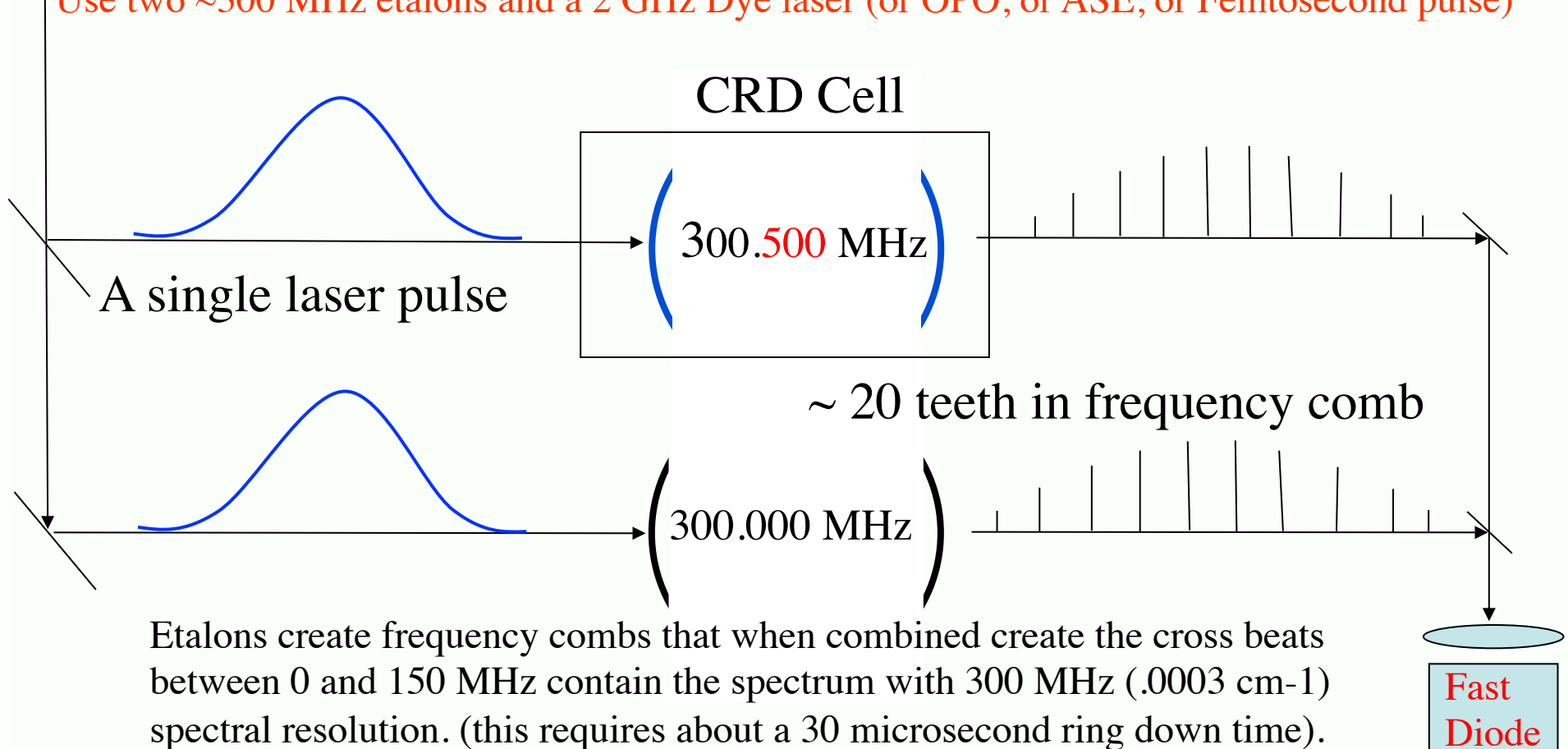

Etalons create frequency combs that when combined create the cross beats between 0 and 150 MHz contain the spectrum with 300 MHz (.0003 cm^{-1}) spectral resolution. (this requires about a 30 microsecond ring down time).

Reference: S. Schiller Opt. Lett. 27, 766 (2002), Hansch (2006), Keilmann (2005), Jun Ye (2007), Nathalie Picque 2010

D. W. Chandler , K. E. Strecker

The Frequencies Expected in the Combined Etalon Signal Have Cross Beats That are Ordered in a Manner to Allow One to Perform Spectroscopy.

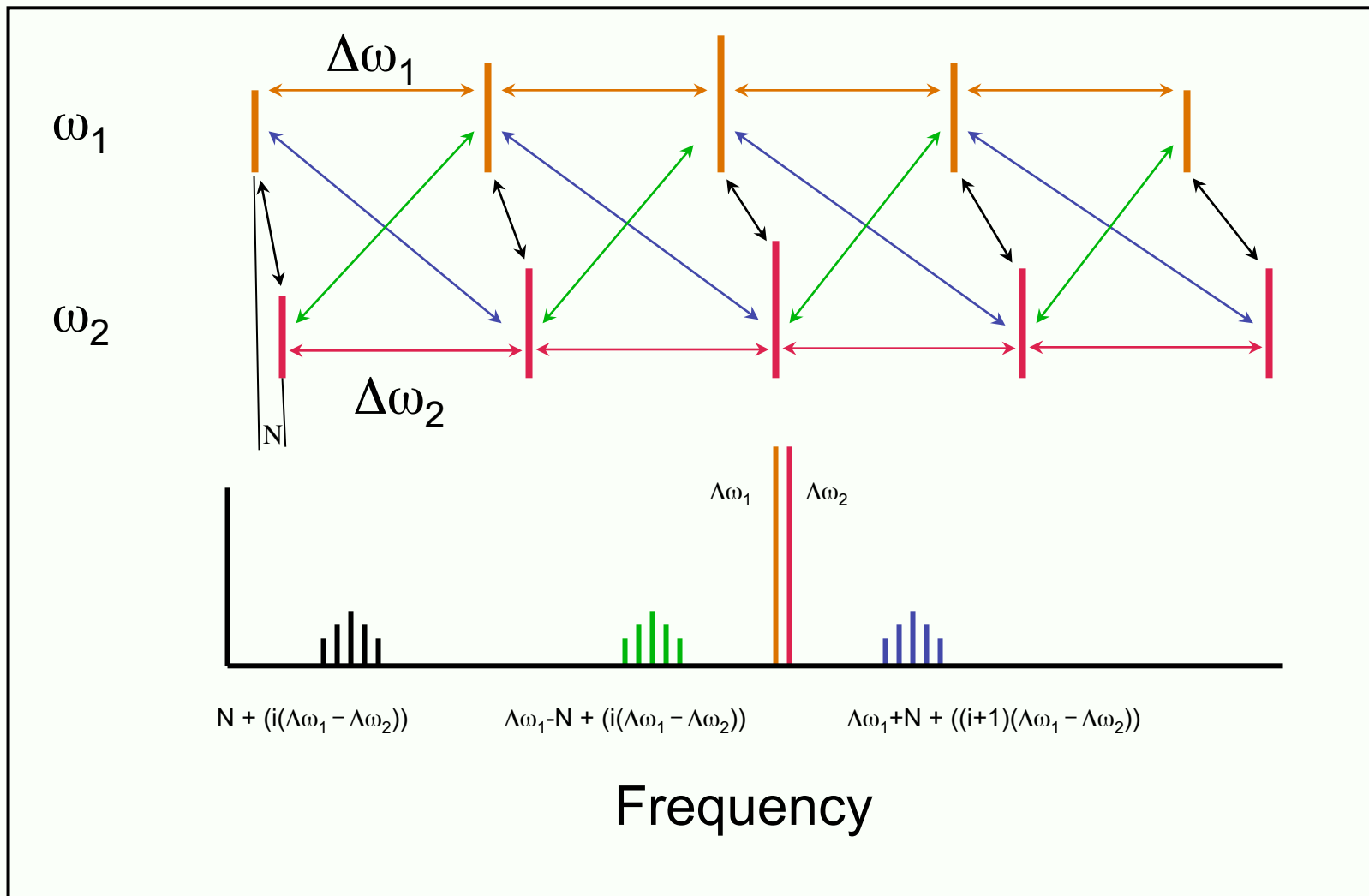

By Fourier Transforming the Interferogram in Segments and Plotting the Intensity of Each Cavity Mode Separately one can do Multiplexed Cavity Ring Down Spectroscopy and Get Resolution of .

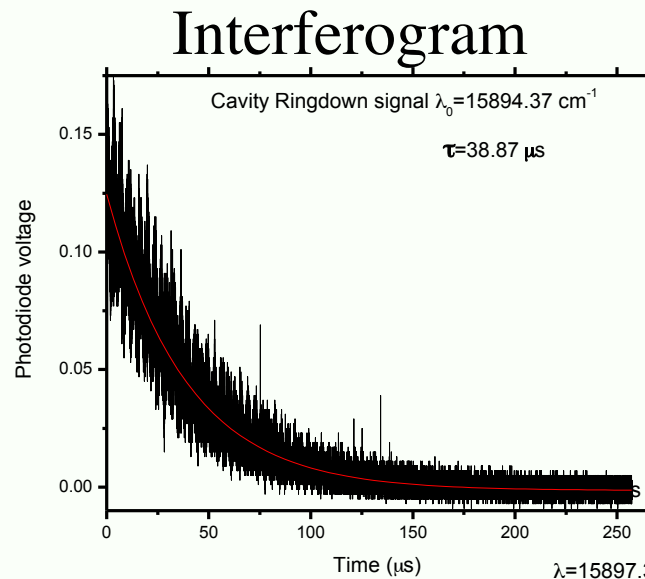

FFT
of segment

Cross Beats / Cavity Modes

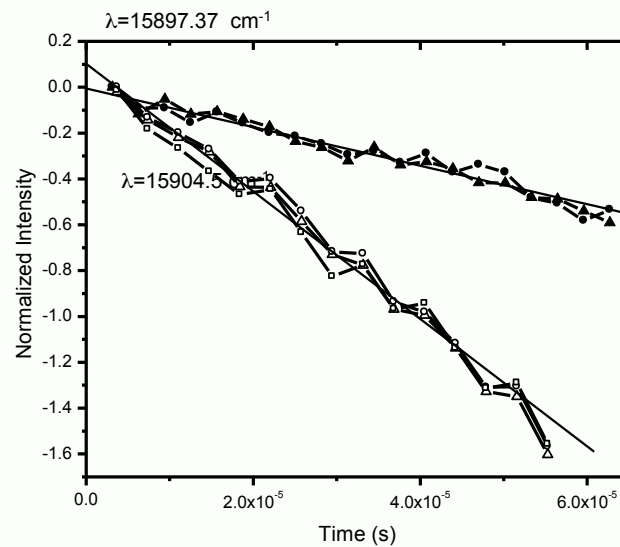
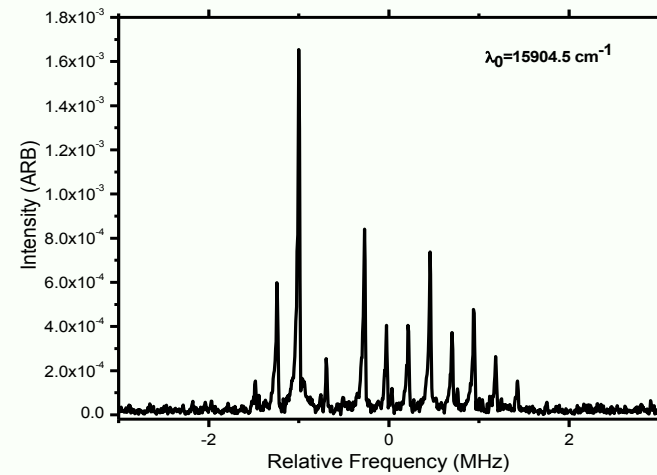

Decay Time For
Each Mode Determined

Preliminary Cavity Ring Down Spectra of O_2 forbidden $b^1\Sigma_g^+ \leftarrow X^1\Sigma_g^+$ and H_2O $4v+0$ (113) \leftarrow (000) Overtone have been Recorded. Single Shot Measurements are Shown at Bottom of Spectrum

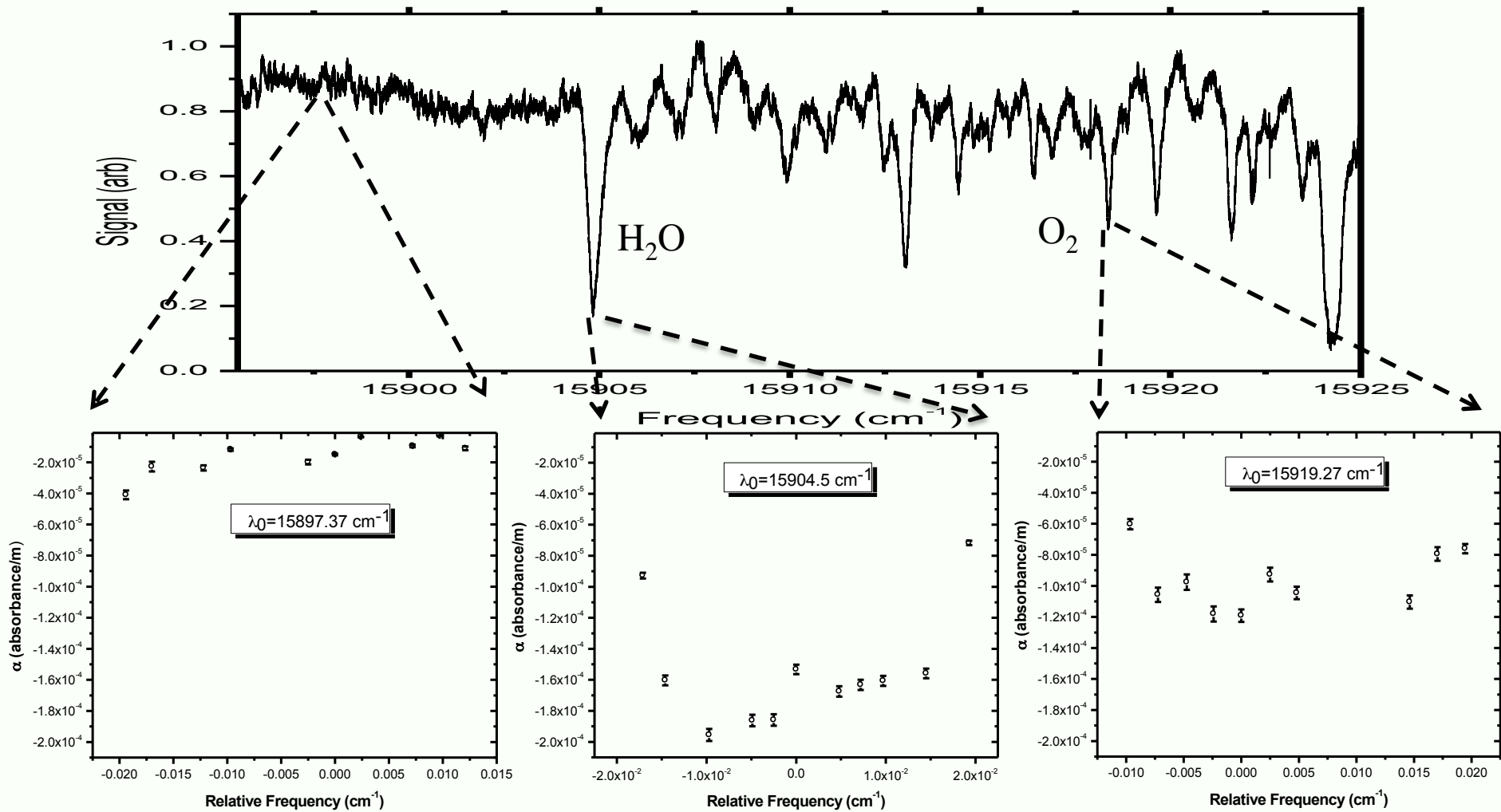

D. W. Chandler , K. E. Strecker